

RCB/BBB/04-02/04/NIT/04/2018-19

Dated: 13.06.2018

NOTICE INVITING TENDER

Sealed Tenders are invited from reputed civil contractors in two bid system, on behalf of the Executive Director, Regional Centre for Biotechnology, Faridabad for work of “Design, Supply & Fixing of Acoustic Gibson Board sound proof Double Layer stuffed Partition with Glass Wool” in Conference Room, First Floor of Regional Centre for Biotechnology and Bio-Science BioNEST Bio-Incubator, at NCR Biotech Science Cluster, Faridabad, as per schedule and General terms & conditions available at www.rcb.res.in, eprocurement.gov.in and at Regional Centre for Biotechnology.

Name of Work: **Design Supply and Fixing of Acoustic Gipsion Board sound proof Partition Double Layer staffed with Glass Wool.**

01. Estimated cost: ₹ 3.50 Lac
02. Earnest money: ₹ 7,000/-
03. Last date of sale of tender: 15.06.2018 up to 15:00 H r s.
04. Last date of receipt of tender: 22.06.2018 up to 15:15 Hrs
05. Date of opening of the tender: 22.06.2018 at 15:30 Hrs
06. Time of completion of job: 21 days from date of issue of Work order
07. **Pre-qualification criteria:**

1	Tender fees	Tender fees of ₹ 500 in the form of Demand Draft from nationalized/scheduled bank drawn in favour of “ Executive Director Regional Centre for Biotechnology ”, Payable at Faridabad.
2	Earnest Money Deposit (EMD)	EMD of ₹ 7,000/- in the form of Demand Draft from Nationalized/scheduled bank drawn in favour of “ Executive Director Regional Centre for Biotechnology ”, Payable at Faridabad.

3	Bidder must have completed similar work like Sound Proofing work etc. of One work of value more than 2.80 Lac. or, Two works of value more than 2.10 Lac, or Three works of value more than 1.40 Lac	Experience Certificate of Acoustic/Sound proofing work carried out satisfactorily in any amounting to minimum Rs. 3 lacs totaling during last F.Y. 2015-16, 2016-17 and 2017-18. Completion Certificate issued by Executive Engineer/ Authorized officer must be enclosed along with bid.
4	Financial Turnover	Annual turnover for last three years F.Y. 2015-16, 2016-17 and 2017-18.
5	GST, PAN	Contractor should produce GST registration & PAN CARD copy

SUBMIT FOLLOWING DOCUMENTS WITH TECHNICAL BID:

- (a) The Bidder should be Reputed contractor/Supplier and must have executed similar (acoustic proofing) civil works in Govt./ PSU/Autonomous bodies or Reputed private sector.
- (b) Attested copy of power of attorney, if any, for signing the Tender documents.
- (c) Bidder should have its firm/ and or office in Delhi-NCR.
- (d) Copy of eligibility criteria Document must be submitted along with Draft of EMD **in technical bid.**
- (e) The sealed price bids should be submitted in separate sealed envelope super scribed accordingly on the envelope.
- (f) Copy of tender document page numbered, signed and stamped on each page by authorized signatory of agency.
- (g) Both “Technical” and “Price” bid should be in separate envelops and then put in to outer common envelope, super scribing the name of the work and tender opening date etc.

Credentials of tenderer

- 1.1 Name of the Agency:
- 1.2 Office Address and Tel Nos.
- 1.3 Registration details (with documentary evidence) (With documentary evidence)
- 1.4 PAN No. (with documentary evidence)
2. Annual turnover for last three years supported with documentary evidence)
3. Experience (last three years)
- 3.1 Contract details fulfilling eligibility criteria

Financial bid envelop must contain duly filled, signed and stamped financial bid. The both envelops should be super-scribed clearly with Name of work and NIT No, providing name(s) and postal address of the Bidder with Phone/ Mobile/ Fax numbers and e-mail address if any.

The offer shall remain open for at least 60 days. Earnest Money Deposit (EMD) amounting to ₹ 7,000/- shall be accepted only in the form of Demand Draft drawn in favour of the **Executive Director, Regional Centre for Biotechnology**, payable at Faridabad. EMD and tender fee must be enclosed with technical bid failing which, bid will summarily be rejected.

Executive Engineer

TECHNICAL SPECIFICATIONS: -

1. SCOPE:

The specification covers **Design, Supply & Fixing of Acoustic Gipson Board sound proof Double Layer stuffed Partition with Glass Wool, in Conference Room, at First Floor of BBB and RCB at NCR Biotech Science Cluster, Faridabad** as per design & drawing of RCB.

2. Design & Drawing:

The bidders are advised to visit the site and assess the scope of work as since attached drawings are indicative.

3. Quality / Standards of Material to be used:

Basic material to be used Gibson board and Glass wool for the partition. Hence material should of standard quality of reputed manufacturers & name of manufacturers is to be specified in bid.

The wall of the chamber will be cavity walls filled with Sound proofing insulation material.

The finished Double Layer sound proof Partition must satisfy

- Noise criteria shall be 30dB(A) or better
- Transmission loss 30dB(A) or better
- Reverberation 0.6 sec or better

(Base layer 5/8" Sound break XP Gypsum Board vertically applied to 3-5/8" steel studs spaced 24" o.c. Two layers 5/8" Fire-Resistance Rated Gypsum Board vertically applied to opposite side. Base layer attached with 1" type S screws 24" o.c. Face layer attached with 1-5/8" type S screws 12" o.c. Vertical joints staggered 24" each layer and opposite sides. 3-1/2" glass fiber in stud cavity.)

GENERAL CONDITIONS

1. Time limit 21 days from the date of the order issued.
2. No Extra charge or any escalation charge will be paid by Centre.
3. Inferior and Poor quality material will be rejected and work order may be cancelled.

GENERAL TERMS AND CONDITIONS

Name of Work: Design, Supply & Fixing of Acoustic Gibson Board sound proof Double Layer stuffed Partition with Glass Wool” in Conference Room, First Floor of RCB and BBB, at NCR Biotech Science Cluster,

01. The Work shall be done as per schedule of items, specification terms and conditions and instruction of Engineer-in-charge on as and when required basis.
- 02 The Completion time would be 21 days.
- 03 In case of delay, a penalty of 0.5 % of tender value per week will be deducted. Subjected to a maximum of 5% of tender value.
However, for any reason beyond the control of the bidder, the extension of time shall be granted upon application by the contractor in prescribed format. No claim for any compensation during the extended period shall be entertained and the centre’s decision in this regard shall be final.
- 04 The measurement shall be done jointly by the Contractor and Engineer-in-charge
- 05 10% ± deviation in quantities would be permitted.
- 06 The rates shall be inclusive of cartage/ loading unloading or any other expenses. GST should be clearly shown separately. Rate must be valid and firm for a period of six months from the date of award of contract/Letter.
- 07 Quantities are indicative and likely to increase. Bidder will have no objection for variation in quantities thereon. Payment will be as per actual Work executed.
04. The lowest bidder will be awarded order for work.
05. The Executive Director, RCB reserves the right to cancel any or all the tenders without assigning any reason.
06. Duly sealed tender shall be dropped in the tender box placed at the reception counter of the RCB building.
07. No escalation in any form either of materials or of labor shall be payable by the Centre.
08. All materials brought at site shall be got approved by the Engineer-in-charge before

being used

09. No T & P shall be supplied by the Institute.
10. No advance payment shall be made.
11. Security **deposit of 5%** of bill amount will be deducted and same will be released after successful expiry of defect liability of six months from date of completion of Work. EMD amount of success bidder will be adjusted against Security Deposit.
12. EMD of unsuccessful bidders will be returned after finalization of tender.
13. For proper completion of the work, if any quantity variation or extra items are required, the bidder shall execute the same. Rates of extra items shall be derived from the tender itself as far as possible or else prevailing market rates shall be adopted.
14. In case the bidder resiles from the offer within the validity of tender or contractor fails to work as per specification after issue of the award letter, the earnest money will be forfeited. Other suitable administrative punitive action may also have imposed as deemed fit.

Executive Engineer

Price Bid
Schedule of work

Name of Work: Design, Supply & Fixing of Acoustic Gibson Board sound proof Double Layer stuffed Partition with Glass Wool” in Conference Room, First Floor of RCB and BBB, at NCR Biotech Science Cluster,

Sl.No	Description of Item	Unit	Qty.	Rate Rs	Amount Rs
1	DFS&I of Acoustic Gipson Board Partition Double Layer staffed with Glass Wool Work <u>Gypsum Board:</u> Make:- Gypsum India Thickness ¾” Size- 4’ wide and 10-14’ long <u>Glass wool</u> Make: U.P Twinga & Armacell Density: 16kg/m ³ Thickness: 25mm Material: Glass Scoria Type: Bounded fiber glass wool. Gypsum board tight on GI membrane				
I	Conference Room, First Floor at BBB Building	Sqft.	363		
II	Class Room, First Floor, Wing-II at RCB building.	Sqft.	375		

Total

SGST %

CGST %

Total Amount in Rs

(Rupees _____)

Signature and seal of tenderer

Drawings

150 mm thick Acoustic soundproof partition in BBB Building

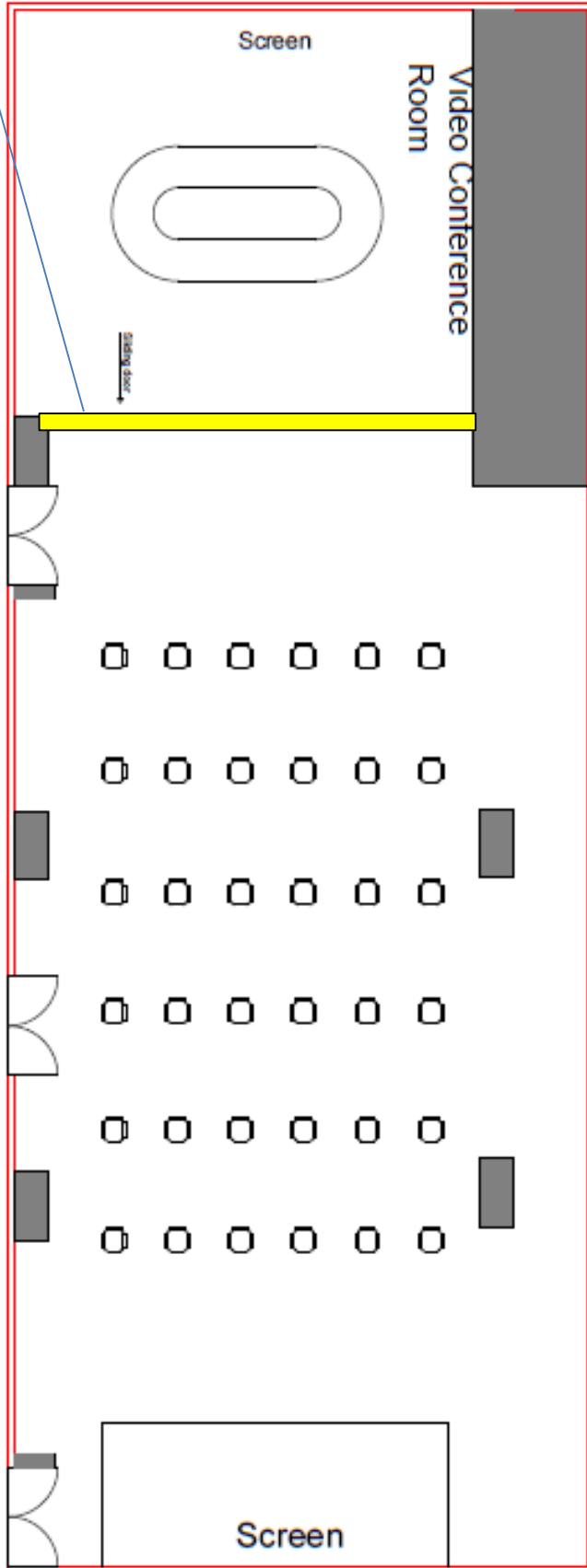

150 mm thick Acoustic soundproof partition in RCB Building

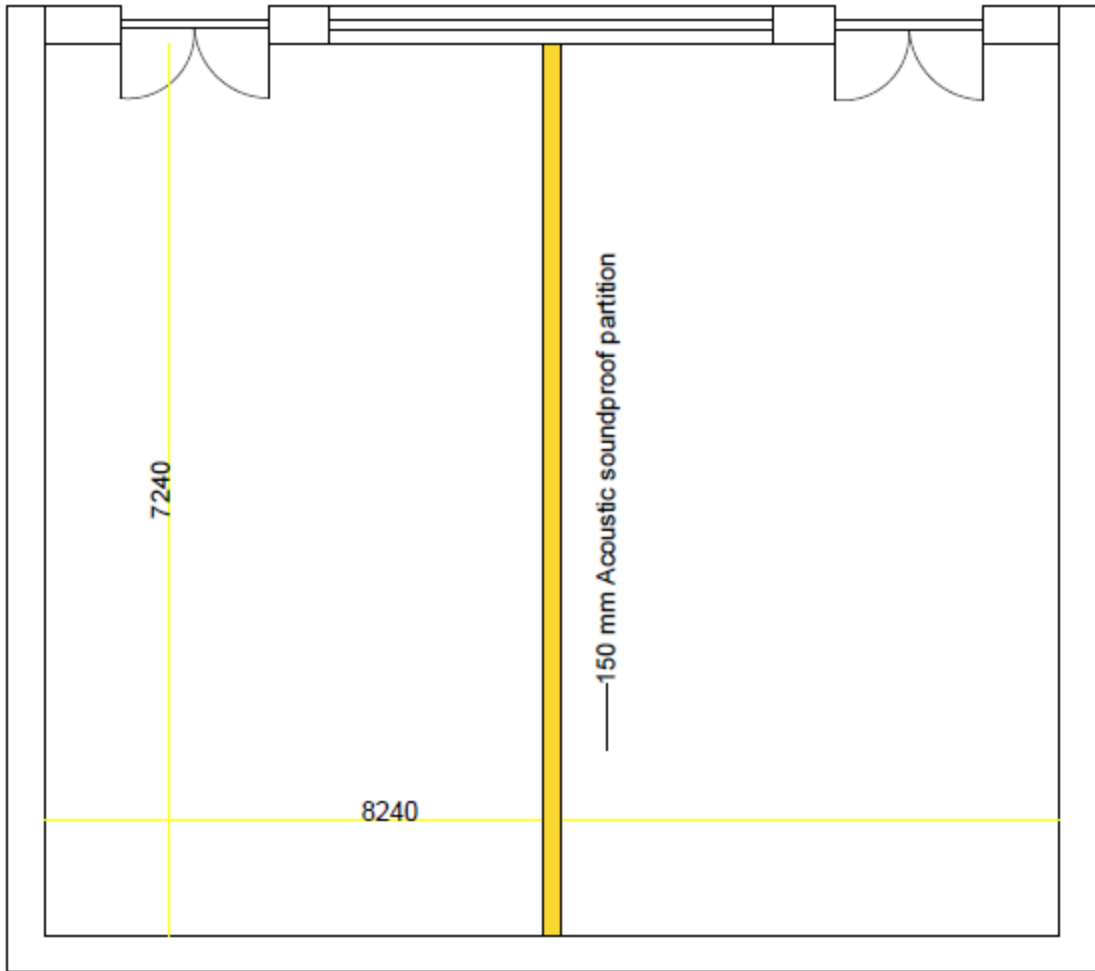

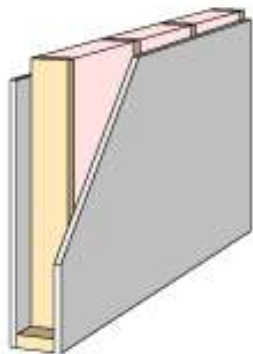
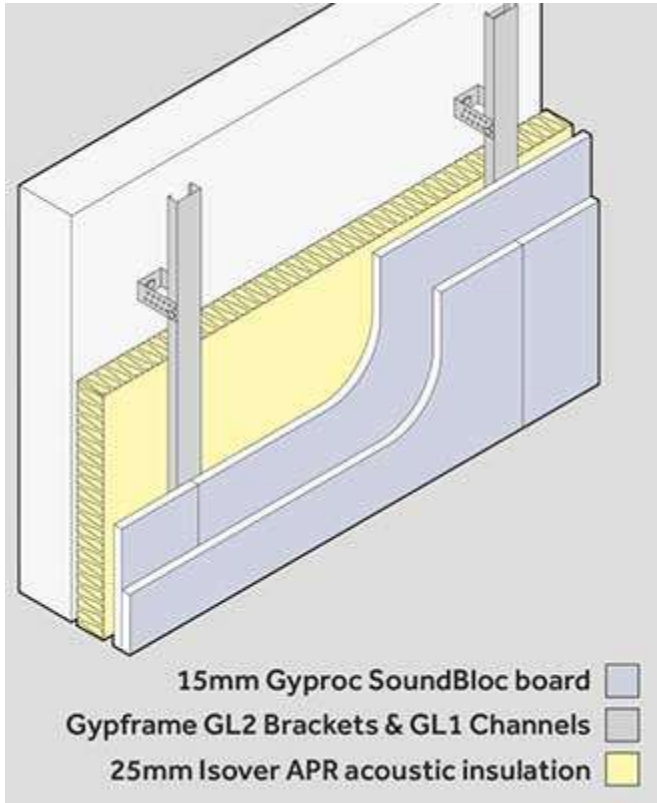

Single Stud Wall Assembly
 R-11 Insulation
 5/8" Type X Drywall
 7/8" Hat Channel
 Wood Studs: 34-39 STC
 Steel Studs: 43-44 STC

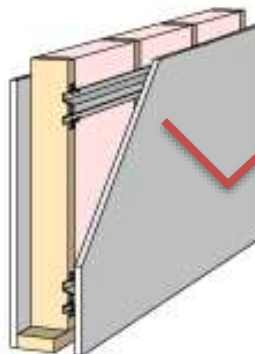

QuietClip Wall Assembly
 R-11 Insulation
 5/8" Type X Drywall
 7/8" Hat Channel
 Wood Studs: 56 STC
 Metal Studs: 59 STC

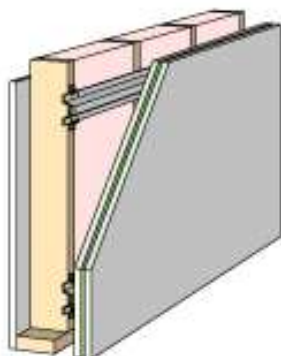

QuietClip & Green Glue Wall Assembly
 R-11 Insulation
 5/8" Type X Drywall
 7/8" Hat Channel
 Wood Studs: 62 STC

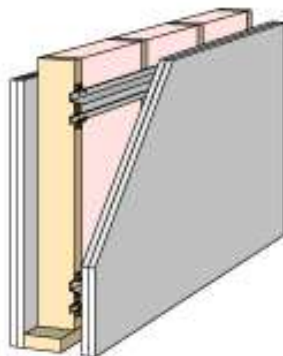

QuietClip Double Drywall Wall Assembly
 R-11 Insulation
 5/8" Type X Drywall
 7/8" Hat Channel
 Wood Studs: 63 STC